

CAVITY BARRIER, FIRE STOP & ACOUSTIC BARRIER SOLUTIONS FOR EXTERNAL WALLS

LAMATHERM EW SYSTEMS have been developed to provide a simple and easy to install method of sealing external wall cavities for both masonry and timber frame constructions.

The standard range has been optimised to include options of materials that are cost-effectively matched to suit the specific performance criteria for all fire stopping requirements. Additionally, the products have excellent sound reduction qualities which can be used to combat unwanted noise via flanking transmission.

These products represent an ideal combination of fully qualified performance, practical installation and cost effectiveness.

Qualified performance

Fire resistance options up to 5 hours
Up to $R_w = 27$ dB sound reduction

Choice of systems

Comprehensive range to suit requirements
Complies with Building Regulations & better

Easy to install

A one-piece product
Accommodates normal site tolerances

Practical, simple & thought-out

Integral foil smoke barrier
Robust yet resilient

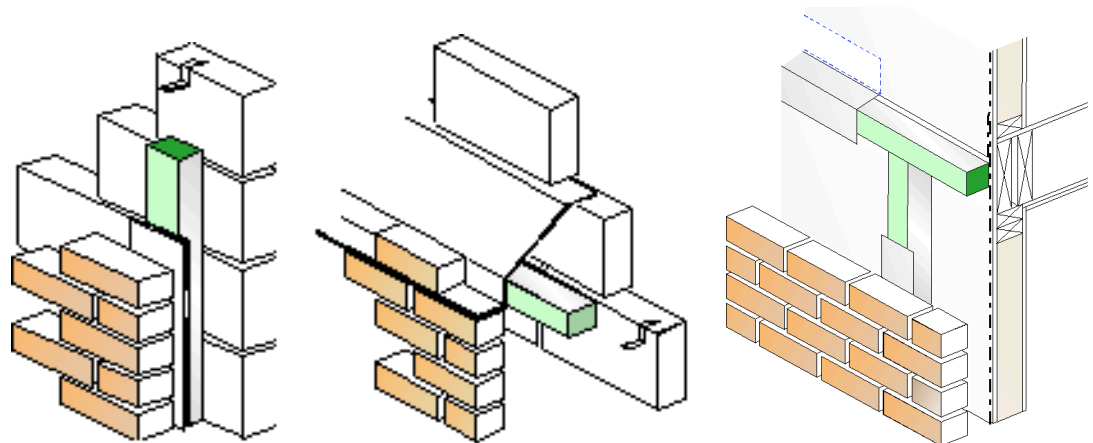

Introduction

The LAMATHERM EW SYSTEMS consist a range of uniquely modified fire safe insulation materials which have been specifically engineered for this application. Throughout the range, the materials comprise a one-piece, close dimensioned product having a pre-compressed internal mineral fibre core. The products have integral aluminium foil facings to provide a Class O rating and excellent resistance to smoke.

A patented method of manufacture provides a resilient lateral compression property which assists installation, ensures the requisite tight fit and, thereby, enhances integrity. The materials are either supplied as pre-cut units to suit a quoted void size or in sheet form for cutting on site.

LAMATHERM EW-CB CAVITY BARRIER systems are used to seal the edges of cavities, including around openings, and to subdivide uninterrupted voids and in accordance with Building Regulations and/or for smoke seal and acoustic qualities.

LAMATHERM EW-FS FIRE STOP systems maintain continuity of fire resistance for installations aligned with fire rated elements and maintain compartmentation.

LAMATHERM EW-FSA ACOUSTIC FIRE STOP combines high fire resistance with enhanced acoustic integrity making it ideal for sealing cavity party walls.



LAMATHERM EW SYSTEMS FOR EXTERNAL WALLS

Applications

Building Regulations require that concealed spaces in a structure of the fabric of a building shall be sealed and subdivided in order to inhibit the unseen spread of fire and smoke. LAMATHERM EW SYSTEMS are suitable as horizontal or vertical cavity fire barriers in all external masonry or concrete cavity walls and when used as a cavity barrier in timber framed buildings with a masonry cladding. The choice of material is simply determined by the performance requirement in terms of fire resistance.

Please note that the fire resistance requirement for cavity barriers is different according to whether the installation is being contracted to the current Building Regulations and National Standards or the more onerous criteria stipulated within The Loss Prevention Council *Design Guide for the Fire Protection of Buildings* where the basic aim is that a compartment in a building should be able to survive the complete burnout.

Description

LAMATHERM EW SYSTEMS comprise a low resin content mineral fibre insulation core which is pre-compressed internally to form a resilient strip. The material is faced on two sides with a reinforced Class O aluminium foil which is an effective smoke barrier.

The materials can be either supplied as pre-cut units to suit a quoted cavity size or in sheet form for cutting on site. Standard sheet product is supplied 1200 x 1200mm and may be of benefit when the actual void size is not known or where it varies significantly. Pre-cut product is available in 1mm increments of width so as to provide a tight compressive fit within the quoted cavity.

For cavities up to 60mm requiring a 15 minute rating and for cavities up to 80mm requiring a 30 minute fire rating, the EW strips are simply compressed within the cavity.

However, for larger cavities (i.e. >61mm for 15 minute fire rating and >81mm for 30 minute fire rating) and for all cavity sizes that require 60 minute, 120 minute and greater fire ratings, each pre-cut EW unit is supplied with fixing brackets to locate the material into position.

The standard brackets are supplied in galvanised mild steel in flat form which is pre-notched to be folded on site to form the requisite "Z" or "L" shape.

Different size fixing brackets are available according to the cavity size.

For cavities up to 150mm the fixing bracket is type B65/110.

For cavities 151-240mm the fixing bracket is type B195.

For cavities 241-400mm the fixing bracket is type B355.

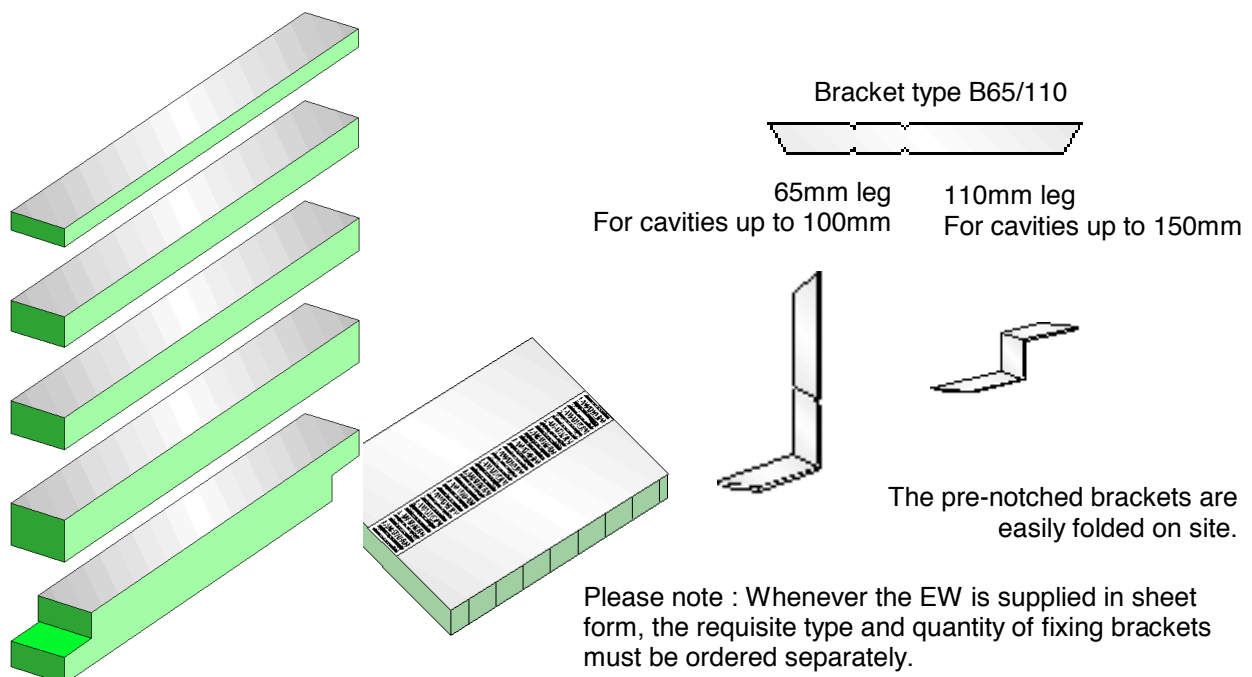

Principles of Installation

The EW-CB CAVITY BARRIERS and EW-FS FIRE STOPS are single components which are simply inserted within the cavity to form a continuous Fire, Smoke and Acoustic barrier.

The EW material must be installed with the un-faced mineral fibre in contact with the sides of the cavity. This means that the foil facing does not touch the sides of the cavity.

Build the EW into the cavity to provide the necessary compression.

Ensure that there are no gaps and that all joints, including horizontal / vertical intersections are tightly abutted.

For cavities <80mm : measured cavity size + 2-5mm compression required.
For cavities >81mm : measured cavity size + 5-10 mm compression required

For a 15 minute fire rating:

For cavities <60mm : no fixing brackets are required.

For cavities >61mm : two fixing brackets are required per 1200mm length.

For a 30 minute fire rating:

For cavities <80mm : no fixing brackets are required.

For cavities >81mm : two fixing brackets are required per 1200mm length.

For 60 minute and 120 minute fire ratings:

For all cavity sizes : two fixing brackets are required per 1200mm length.

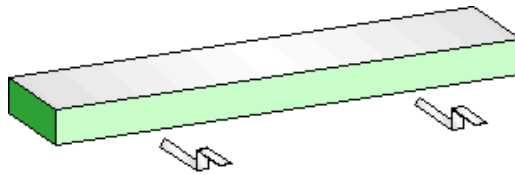

The brackets are impaled into the EW material at nominal 600mm fixing centres i.e. 300mm from each end.

The fixing brackets are impaled into the material at mid-thickness and can be used either as a direct fixing into the green mortar or as a simple angle bracket for mechanical fixing to the inner structure with non-combustible fixings e.g. shot-fire nails, metal anchors or screws etc. No plastic plugs.

The brackets must impale the EW strip by about 75% of the cavity width.

The flat pre-notched fixing brackets are easily folded on site to suit and can be trimmed with 'snips'.

Where the cavity is smaller than the section available, the product can be trimmed on site with a sharp serrated knife providing that the compression allowance is maintained.

Also, if used in sheet form, the product must be cut to provide the requisite compression fit.

LAMATHERM self-adhesive foil tape may be applied to seal the joints between adjacent units and, thereby, maintain the continuity of the impervious foil smoke barrier facings.

Installation requirements

As with any proprietary cavity barrier system, closing a masonry cavity wall with an obstruction potentially affords a bridge for damp penetration. To that end, the installed EW must be damp-proofed in accordance with B.S. 5628 Part 3 1985 Code of Practice for Use of Masonry

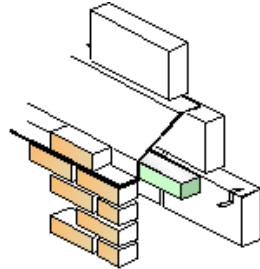

For horizontal installation, the EW must be installed with a cavity tray immediately above.

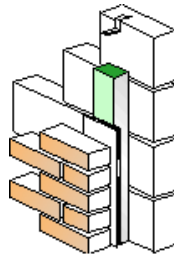

For **vertical installation**, the EW must be installed with a d.p.c. extending min. 25mm into the cavity either side.

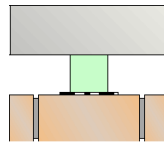

Use as a cavity closer

Inherent thermal properties make the EW particularly suited to the closing of masonry cavities at sill and jamb details - thereby providing the additional benefit of eliminating the potential risk of cold bridging in accordance with Building Regulations. The use of EW strips in these situations eliminates the need for conventional brick / block cavity closers.

EW's thermal conductivity : $\lambda = 0.037 \text{ W/m.K}$.

BRE Document : 'Thermal Insulation - avoiding risks' requires that for closers which incorporate insulation material with a thermal conductivity no greater than 0.04 W/m.K, the window or door frame must be set back to overlap the insulation by at least 25mm.

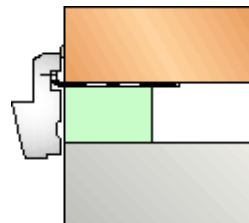

JAMB
Vertical d.p.c. fixed to frame and sealed

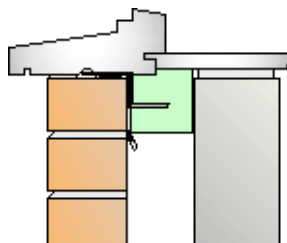

SILL
D.p.c. dressed over face of EW strip

Wherever EW is used as a cavity closer, it is recommended that two fixing brackets are used required per 1200mm length so as to assist with product location and to secure the material in position to resist any potential dislodgement by following trades.

Use at party walls

As well as providing a qualified fire seal, all LAMATHERM EW SYSTEMS satisfy Building Regulation and National Standards requirements for the control of flanking transmission in dwellings constructed with masonry walls.

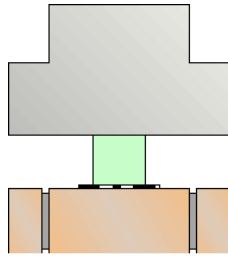

Solid compartment walls:

For this application the appropriate type of EW system is selected to match the fire resistance of the compartment wall.

They are simply installed vertically at the junction of solid compartment walls and external walls so as to extend the line of fire resistance and maintain the compartmentation.

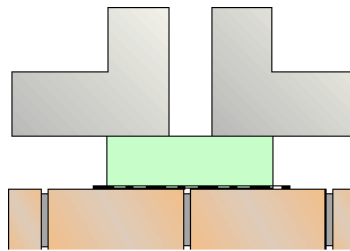

Junctions between compartment cavity walls and external cavity walls are to be stopped with LAMATHERM EW ACOUSTIC FIRE STOP (EW-FSA300) which has been designed for this application.

Being installed at a standard width of 175mm, the material is suitable to seal all normal compartment wall cavity sizes

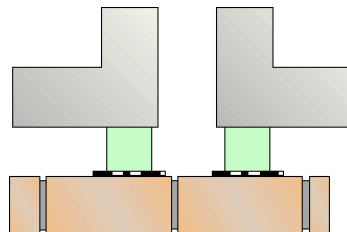

For compartment walls formed with large cavities i.e. >100mm (where the use of the 175mm wide EW ACOUSTIC FIRE STOP would not provide adequate bearing on each inner leaf, the junction is sealed using 2No. parallel installations as shown.

Use within Timber Frame construction

Requirements for cavity barriers are currently different in England, Wales and Northern Ireland from those in Scotland. According to the individual requirement, the EW SYSTEMS are positioned so that they:-

Limit the size of the cavity (They should be in line with a timber stud)

Seal the cavity in the line of a compartment or separating wall.

Seal the cavity in the line of a compartment floor.

Seal the cavity around the opening for a window or doorset.

A summary of the possible provisions of cavity barriers in dwellings includes:-

- [a] intermediate floors and upper ceiling level in compartment walls.
- [b] At eaves
- [c] At junctions of separating and compartment wall and external wall.
- [d] Around openings.
- [e] Vertical barriers are required at max centres specified in regulations.
- [f] At intermediate floor junctions with walls.
- [g] Verge or ceiling level (verge if roof space includes accommodation).

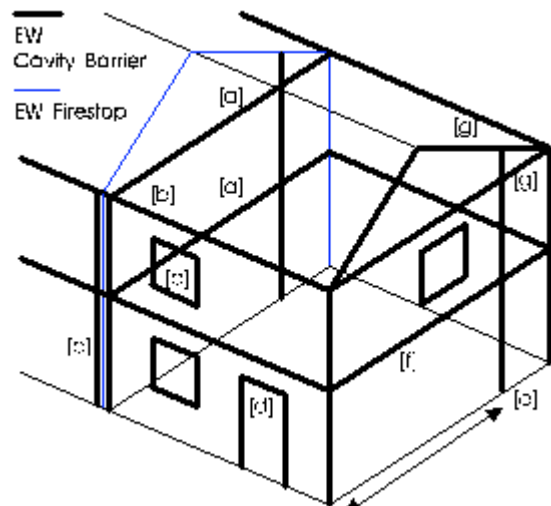

LAMATHERM EW SYSTEMS FOR EXTERNAL WALLS

When used in timber frame constructions, LAMATHERM EW SYSTEMS are available to seal external wall cavities up to 150mm maximum for up to 60 minutes fire rating.

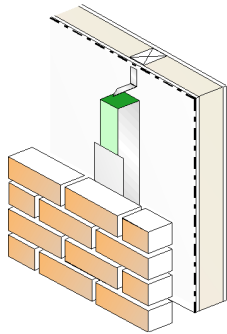

Vertical installation:

EW SYSTEMS are aligned with studs.

For cavities up to 60mm requiring a 15 minute rating and for cavities up to 80mm requiring a 30 minute fire rating, the EW strips are simply compressed within the cavity. However, for larger cavities (i.e. >61mm for 15 minute fire rating and >81mm for 30 minute fire rating) the EW must be secured with brackets which are fixed to the studs and not sheathing alone.

D.p.c. extends min. 25mm either side of the EW.

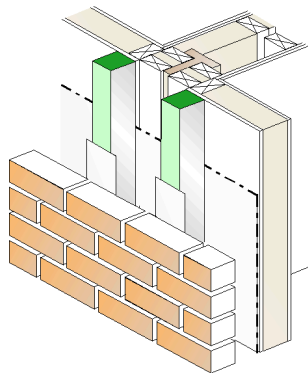

Two parallel installations are required at separating walls - each installation being aligned and secured to studs.

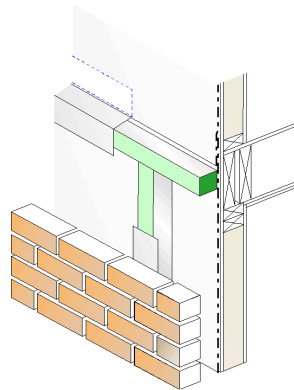

EW SYSTEMS incorporated in external wall at intermediate floor level.

D.p.c. over horizontal EW is tucked beneath breather membrane.

The joint between horizontal and vertical barriers must be tightly abutted and the horizontal d.p.c. lapped over the vertical d.p.c.

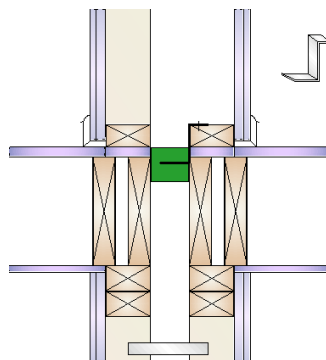

Additionally, the EW can be used as a seal at the junction of an internal compartment wall and floor.

Where the fixing brackets are used, these are folded to a 'Z' shape with one leg overlapping and fastened to the bottom horizontal rail of the timber framework of the upper compartment wall. Each bracket is fastened with a steel nail or screw at least 25mm long.

The fixing bracket is impaled into the EW and secured at nom. 600mm centres.

Fire

The design and manufacture of the range of LAMATHERM EW SYSTEMS is based on proven fire performance to BS 476 : Part 20 : 1987.

Verification of fire performance is available upon request.

Based on multiple tests, each material option has been formally assessed by The Loss Prevention Council to meet the relevant performance rating given.

FIRE RATING TABLE							
PRODUCT RANGE				Size		BS 476 Pt 20	
SYSTEM Product code	Nominal Fire Rating	Void Size Limitation		Material Thickness (mm)	Cover Length (mm)	Integrity (mins.)	Insulation (mins.)
		Masonry cavities	Timber Frame				
EW-CB15	15 mins.	150mm	150mm	50	1200	30	15
EW-CB30	30 mins.	150mm	150mm	75	1200	30	30
EW-FS60	60 mins.	400mm	150mm	90	1200	300	60
EW-FS120	120 mins.	400mm	-	120	1200	300	120
EW-FSA300	300 mins.	400mm	-	175	1125	300	300

Please note:

When ordering the EW SYSTEMS as pre-cut strips, dedicated fixing brackets are supplied as part of the system as follows:

FIXING BRACKET REQUIREMENT				
Standard Pre-cut strip SYSTEM	No brackets supplied	Void Size (mm)		
		Up to 150mm	151-240mm	241-400mm
EW-CB15	Voids <60mm	2No. B65/110 Per unit length		
EW-CB30	Voids <80mm			
EW-FS60			2No. B195 Per unit length	2No. B355 Per unit length
EW-FS120				
EW-FSA300				

Please note void size limitation for each system as tabled above.

Acoustics

The LAMATHERM EW range additionally provides an effective sound barrier as the material construction and inherent properties of the mineral fibre core afford the EW exceptional acoustic performance. Their acoustic performance is attributable to the mass of the mineral fibre core coupled to the unique resilient lamella board internal construction. Also, the foil facings and the additional sealing of joints with foil tape all serve to provide improved air tightness.

Based on laboratory tests to determine airborne sound transmission in accordance with BS EN ISO 140-3 : 1995, BS 2750 : Part 3 : 1995 on a variety of lamella board constructions, the following Weighted Sound Reduction Index (R_w) values can be used:-

Weighted Sound Reduction Index		
EW SYSTEMS	Thickness	R _w
EW-CB15	50mm	17dB
EW-CB30	75mm	21dB
EW-FS60	90mm	22dB
EW-FS120	120mm	25dB
EW-FSA300	175mm	27dB

* = R_w value interpolated from test results.

Sound Research Laboratories Limited test report no. : C/99/5L/7743/1 refers.

When properly installed at external masonry cavity wall junctions, the EW SYSTEMS will significantly reduce any potential flanking transmission.

The precise value will depend upon the specifics of the construction.

LAMATHERM EW-CB CAVITY BARRIERS for external cavity walls

Definition of a cavity barrier,

"A construction provided to close a concealed space against penetration of smoke or flame, or provided to restrict the movement of smoke or flame within such a space."

EW-CB15

Approved Document B to the current Building Regulations requires that cavity barriers must have a minimum standard of fire resistance of 30 minutes with regard to integrity and 15 minutes with regard to the insulation criteria respectively.

The LAMATHERM EW-CB15 CAVITY BARRIER meets all relevant current provisions for cavity barriers.

Specifically, these include:-

In England and Wales, Approved Document B3 to the Building Regulations 2000.

In Scotland, Part D4 of the Building Standards (Scotland) Regulations 1990.

In Northern Ireland, Technical Booklet E, Section 3.27, The Building Regulations (Northern Ireland) 1994.

In Eire, Technical Guidance Document B, Section 3.3, The Building Regulations 1991

EW-CB15 is 50mm thick and provides 15 minutes insulation and 30 minutes integrity criteria when installed in masonry walls, concrete walls and masonry clad timber frame cavity walls up to 150mm maximum.

The EW-CB15 is available with a simple butt joint and provides a 1200mm unit length.

EW-CB30

Developed in recognition of the more demanding requirements of the *'Design Guide for the Fire Protection of Buildings'* as issued by The Loss Prevention Council.

EW-CB30 is 75mm thick and provides 30 minutes insulation and 30 minutes integrity criteria when installed in masonry walls, concrete walls and masonry clad timber frame cavity walls up to 150mm maximum.

The EW-CB30 is available with a simple butt joint and provides a 1200mm unit length.

LAMATHERM EW-FS FIRE STOPS for external cavity walls

Definition of fire stopping,

"Sealing an imperfection of fit or design tolerance between fire rated elements of a building to restrict the passage of fire and smoke for the same period of fire resistance."

For the purposes of our product terminology, the *'imperfection of fit'* is considered to be the discontinuity between the internal fire rated structure (e.g. Compartment wall or compartment floor) and the interface with the external masonry.

LAMATHERM CW-FS FIRE STOPS are used to maintain continuity of fire resistance by sealing the gap between compartment walls or floors and the external wall.

EW-FS60

Is suitable for installation in alignment with a 1 hour rated compartment wall or floor to provide continuity of fire resistance across the cavity.

EW-FS60 is 90mm thick and provides 60 minutes insulation and 300 minutes integrity when installed in masonry or concrete cavities up to 400mm wide maximum and is formally assessed to provides a one hour rating in timber frame cavities up to 150mm maximum.

It offers a simple butt joint and provides a 1200mm unit length.

EW-FS120

Is suitable for installation in alignment with a 2 hour rated compartment wall or floor to provide continuity of fire resistance across the cavity.

EW-FS120 is 120mm thick and provides 120 minutes insulation and 300 minutes integrity criteria when installed in external masonry or concrete cavities up to 400mm wide maximum.

It offers a simple butt joint and provides a 1200mm unit length.

EW-FSA300 ACOUSTIC FIRE STOP

Is suitable for installation in alignment with a 4 hour compartment wall or floor to provide continuity of fire resistance across the cavity.

EW-FSA300 is 175mm thick and provides 300 minutes insulation and 300 minutes integrity criteria when installed in external masonry or concrete cavities up to 400mm wide maximum.

The material is supplied with a 75mm rebate to provide an overlap joint and 1125mm unit cover length. The overlap joint assists with location during installation and ensures the integrity of the seal.

The standard 175mm thickness offers the EW-FSA300 ACOUSTIC FIRE STOP exceptional sound reduction properties. When installed at the junction of compartment cavity walls and external masonry walls, the material is able to effectively bridge across and seal the construction so as to prevent the passage of both fire and sound. It is suitable for all normal cavity sizes providing that the material is able to maintain a physical bearing on both leaves of the compartment cavity wall. As such, it is recommended that its' use is limited to compartment cavity walls where the cavity is sized <100mm maximum.

Please note: Where the EW-FSA300 ACOUSTIC FIRE STOP is used for enhanced acoustic performance in situations requiring up to a 30 minute fire rating, the material may be installed without any fixing brackets in cavities up to 80mm maximum.

PRODUCT SELECTOR			
<i>Where is the product required?</i>	<i>What performance is needed?</i>		<i>Which system do I need to specify?</i>
Subdivision of large uninterrupted cavity	To comply with Building Regulations requirements for cavity barriers.		EW-CB15
	To comply with LPC Design Guide requirements for cavity barriers.		EW-CB30
Around openings	To comply with Building Regulations requirements for cavity barriers.		EW-CB15
	To comply with LPC Design Guide requirements for cavity barriers.		EW-CB30
Alignment With Compartment Walls and/or Floors	Match fire resistance	30 minutes	EW-CB60
		60 minutes	EW-FS60
		120 minutes	EW-FS120
		240 minutes	EW-FSA300
At junctions with compartment cavity walls	Compartment wall cavity size <100mm		EW-FSA300
	Compartment wall cavity size >100mm		2No. FS60
Please note void size limitations for individual systems.			

Selection advice regarding the appropriate EW system for a given application is always available from the technical helpline.

Properties

Chemical

The base mineral fibre is chemically inert. An aqueous extract of the rock wool is neutral (pH7) or slightly alkaline. Resistant to most acids and weak alkaline solutions.

Biological

Vermin and rot proof and does not encourage the growth of fungi, moulds or bacteria.

Thermal conductivity

$\lambda = 0.037$ w/m.K at mean temp. 10 deg. C.

Effect of water

Non-hygroscopic. Unaffected by humid atmosphere.

Environmental

No CFC's or HCFC's are used in the manufacture of the base materials.

Ozone depletion potential is zero. Non-toxic. No known health hazards.

Compatibility

Compatible with all normal building materials.

Durability

To the lifetime of the building unless disturbed.

Maintenance

No maintenance required unless disturbed. Annual inspections are desirable to recognise any mechanical damage and the necessary repairs made. Must be properly reinstated when penetrating services are re-routed.

Packaging

Standard pre-cut strip product is supplied in cardboard cartons. Maximum carton weight is nom. 35kg. Sheet product can either be supplied in cardboard cartons and/or on dedicated pallets as required.

Handling

Easy to handle but should be treated with due care to ensure material integrity and shape are maintained.

Storage

Store in dry conditions.

Ancillary materials

Lamatherm offers a full range of ancillary products to complement the EW range. These include:-

Standard Fixing Brackets

B65/110

B195

B355

Supplied in flat-notched form to fold on site.

Stainless steel alternatives and other non-standard brackets are available subject to enquiry.

Self-adhesive foil tape

RFT120/45

(120mm wide x 45m rolls)

For end-joint sealing to maintain smoke barrier : all EW systems

Complementary systems

LAMATHERM FM TROWEL GRADE FIRE MASTIC

LAMATHERM GA-FS240 GAP SEALANT FIRE STOP

The above information is available upon request.

Complementary data sheets

LAMATHERM EW SYSTEMS Verification of fire performance

LAMATHERM EW SYSTEMS Material Safety Data Sheet

LAMATHERM EW SYSTEMS Sheet Cutting instructions

Lamatherm have a national distribution network enabling fast delivery to site directly from stock.

Information regarding the following customer service options is available direct from Lamatherm Sales Dept.:-

- Standard *48 Hour* delivery service
- Optional *Next-Day* delivery service
- Optional *Next-Day a.m.* delivery service
- Optional *Next-Day 10 a.m.* delivery service
- Optional *Timed* delivery service
- Discounted *4 Day* delivery service
- Contract Project Pricing* schemes

When ordering, the following information should be provided:-

- The fire rating required
- The size of cavity to be sealed
- The number of lengths or linear metres required, or,
- The number of sheets required.
- Requirement for additional fixing brackets.
- Requirement for foil tapes

Please note that there are separate information sheets available that detail material **CUTTING INSTRUCTIONS** and **MATERIAL SAFETY DATA**. Read these prior to commencing installation.

Please note that when ordering the EW SYSTEMS in sheet form, the requisite quantity of fixing brackets needs to be purchased separately.

For further information regarding other LAMATHERM systems for wide cavity applications and/or for the sealing of voids behind architectural panels & curtain walling please contact the Technical Support Department.

Advice on novel requirements and/or non-standard systems are available on a project basis. Please contact the technical helpline for further information.

For further information including advice on suitability for specific applications, please contact:

Technical Support Department
technical helpline: 01656 812509
email: sales@siderise.com